

ELA ANG DUO 2 MODULE 180W



URBAN LIGHTING LUMINAIRES

IP66

IK08



EN60598 CE

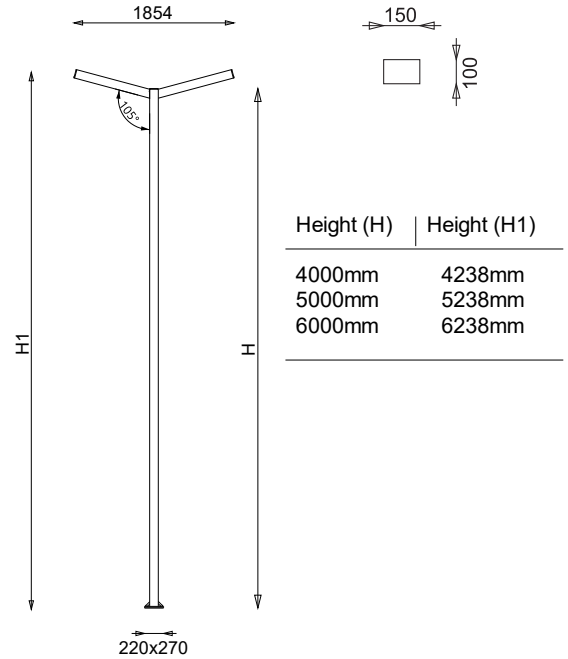

PRODUCT DATA

General Information

Number of light source	48 pcs
LED module	High Power LED's on alu-PCB
Light distribution	Asymmetric
Light source colour	3000K-4000K
Number of gear unit	1 unit
Driver / power unit	PS (Constant current)
Driver included	Yes
Optical cover / lens type	Multi lens
Control interface	On/Off
Connection	-
Cable	3x1,5 mm ²
Protection class IEC	Safety class I
CE mark	CE mark
ENEC mark	-
Warranty period	5 years
Optic type	Asymmetric
EU RoHS compliant	Yes
Light source engine type	LED
LDT / IES photometric file	Available
Life span	Estimated average 50.000 hours
MacAdams	CCT tolerance within a 3 step MacAdams ellipse
Product code	60-74-015-180-48-XX-ASYM-X (XX: Pole height, X: Led colour)

Operating and Electrical

Input Voltage	90-264 V AC
Input frequency	50 to 60 Hz
Inrush current	818 mA
Power factor (min.)	0.92

Control and Dimming

Dimmable(optional)	1-10V - DALI
DMX	-

Mechanical and Housing

Housing material	Aluminium extrusion
Gasket	Silicone
Optic material	PMMA
Optical cover / lens material	PMMA
Fixation material	Stainless steel
Mounting device	-
Effective projected area	7,9m ² - 9,7m ² - 11,6m ²
Colour	Grey
Dimensions (height x width x depth)	4238,5238,6238 x 1854x 150mm

Approval and Application

Ingress protection code	IP66
Mech. impact protection code	IK08
Surge protection (common/differential)	6 KV/4KV

Initial Performance (IEC Compliant)

Module luminous flux	24893 lm (4000K) / 23188 lm (3000K)
Luminaire luminous flux	22630 lm (4000K) / 21080 lm (3000K)
LED luminaire efficiency	125 lm (4000K) / 117 lm (3000K)
Colour Temperature	4000K / 3000K
	6500K also available up on request.
Colour rendering index	≥70
Rated LED power	164 W
Rated luminaire power	180 W

Application Conditions

Ambient temperature range	-25°C to +55°C
Maximum dimming level	-
Net weight (piece)	Variable

Fixture Run Length To calculate fixture run lengths and total power consumption for your specific installation, please ask to company assistant

BAYLED TEKNOLOJİ A.Ş.

Ahi Evran Mah. 225. Cad. No:84 06935, Sincan ANKARA / TURKEY
T: +90 312 395 76 35 | F: +90 312 395 73 65 | sales@bayled.com.tr

Bayled is a Baytaş group brand.

Scan the QR Code to go to the product web page.



We reserve the right to change specifications without prior written notice.

Current version under: www.bayled.eu