

ATLAS QUADRA (4 MODULE) 200W

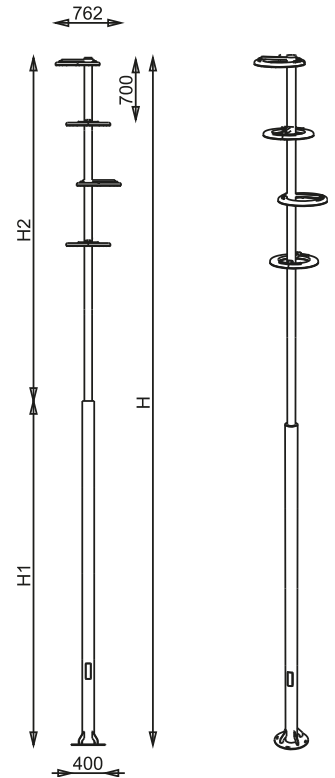

URBAN LIGHTING LUMINAIRES

IP66 IK10 EN60598 CE



Total Height (H)	H1 / H2
8000mm	4000mm / 4000mm
9000mm	4000mm / 5000mm
10000mm	4000mm / 6000mm

PRODUCT DATA

General Information

Number of light source	160 pcs
LED module	High Power LED's on alu-PCB
Light distribution	ASYM
Light source colour	3000K-4000K
Number of gear unit	-
Driver / power unit	PS (Constant current)
Driver included	Yes
Optical cover / lens type	Single lens
Control interface	On/Off
Connection	-
Cable	3x0,75 mm ²
Protection class IEC	Safety class I
CE mark	CE mark
ENEC mark	-
Warranty period	5 years
Optic type	Asymmetric
EU RoHS compliant	Yes
Light source engine type	LED
LDT / IES photometric file	Available
Life span	Estimated average 50.000 hours
MacAdams	CCT tolerance within a 3 step MacAdams ellipse
Product code	60-74-028-200-160-XX-0-X (X: Led colour , XX: Pole height)

Operating and Electrical

Input Voltage	100-305 V AC
Input frequency	50 to 60 Hz
Inrush current	909 mA
Power factor (min.)	0.92

Control and Dimming

Dimmable(optional)	DALI, 1-10V
DMX	-

Mechanical and Housing

Housing material	Aluminium die cast
Gasket	Silicone
Optic material	PMMA
Optical cover / lens material	Plexiglass (5mm)
Fixation material	Stainless steel
Mounting device	-
Effective projected area	6,1m ² - 6,8m ² - 7,6m ²
Colour	Grey
Dimensions (height x width x depth)	8000, 9000, 10000 x 762mm

Approval and Application

Ingress protection code	IP66
Mech. impact protection code	IK10
Surge protection (common/differential)	6KV / 4KV

Initial Performance (IEC Compliant)

Module luminous flux	28785 lm (4000K) / 26814 lm (3000K)
Luminaire luminous flux	26168 lm (4000K) / 24376 lm (3000K)
LED luminaire efficiency	130 lm (4000K) / 121 lm (3000K)
Colour Temperature	4000K / 3000K
	6500K also available up on request.
Colour rendering index	≥70
Rated LED power	182 W
Rated luminaire power	200 W

Application Conditions

Ambient temperature range	-25°C to +55°C
Maximum dimming level	-
Net weight (piece)	Variable

Fixture Run Length To calculate fixture run lengths and total power consumption for your specific installation, please ask to company assistant

BAYLED TEKNOLOJİ A.Ş.

Ahi Evran Mah. 225. Cad. No:84 06935, Sincan ANKARA / TURKEY
T: +90 312 395 76 35 | F: +90 312 395 73 65 | sales@bayled.com.tr

Bayled is a Baytaş group brand.

Scan the QR Code to go to the product web page.



We reserve the right to change specifications without prior written notice.

Current version under: www.bayled.eu