

Purchase Order Table

CODE	MODULE POWER	LUMINAIRE POWER
45-19-155-144-XX-RGB	141W	155W
45-19-255-144-XX-RGB	232W	255W

XX : Lens Angle



TETRA PRL-3 RGB

EN 60598 | IK09 | IP66 | CE

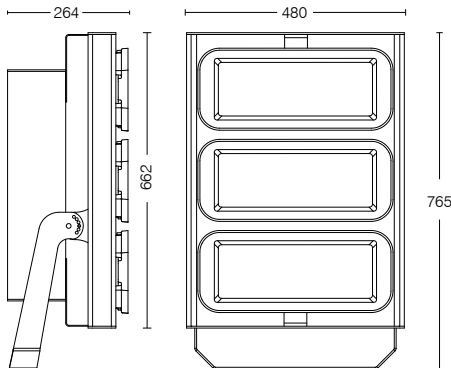

DMX 512

Interface : Data Enabler (DMX/Bayled)
 Address method : DMX512 (RDM)
 Fixture Connections : Male/female IP67 connectors

FIXTURE RUN LENGTHS

To calculate fixture run lengths and total power consumption for your specific installation, please ask to company assistant.

FEATURES

Color-changing and high-quality white light from the same fixture. Tetra is an advanced approach to color mixing that enables high-quality intelligent color. Multiple channels of LED lightsources combine to produce a full spectrum of precisely controllable light, including millions of saturated colors, pastels and uniform white light.

Technical Specifications

Floodlight made of aluminium die cast	DMX 512 / RDM
Galvanized steel fittings	Safety Class I
Clear 5mm safety glass	Protection class IP66
Silicon rubber gasket	Impact strenght IK09
Swivel range 100°	Operation temperature -25°C / +55°C
Mounting bracket made of steel with	Wind catching area: 0,24m²
Electrostatic powder coating	Weight: 23,3 kg
Lens angle 8°-15°-30°-60°-90°	EULUMDAT files available
Color standard MT-X6-23, optional RAL codes	Complies with European standards
Input 85-264 V AC 50 / 60 Hz	EN 60598 and CE certificate
Power factor (min.) 0.92	

Lifetime 50.000 working hours at least



Scan QR Code to get all technical documents and the other updated files for this product.

