

EXPLANATION

SIRUS RGBW(A) Series is a powerful and outdoor rated floodlight with high lumen output and excellent color consistency. SIRUS RGBW(A) are excellent solution for accent lighting, spot lighting, wall washing, façade lighting applications and widely used in illuminating historical places, monuments in parks and other areas.

SIRUS RGBW(A) Series is produced in 32 pcs colored LED. SIRUS RGBW(A) Series has a sturdy die cast aluminium body. It works at universal power input 90 ~ 264VAC to ensure connections over long distances. SIRUS RGBW(A) Series provides easy setup and programming with standard DMX 512 and RDM protocols without special or complex communication protocols.

- SIRUS RGBW(A) provides compatible communication with other fixtures using standard DMX 512 and RDM protocols without requiring any other special communication protocol or production ID. They are remotely addressable in group via RDM protocol. This feature allows for easy pixel mapping and addressing after all installations have been completed.
- SIRUS RGBW(A) floodlights enable flexible application using very long starter and jumper cables, since they operate in 90 ~ 264VAC 50/60HZ universal voltage range.
- SIRUS RGBW(A) Series work through Madrix® or Enttec software and hardware in coordination. Pixel mapping can be made easily by selecting fixtures in Madrix® or Enttec library.
- IP66 class SIRUS RGBW(A), are designed to meet the challenging requirements of exterior applications with their robust and durable structure. It is resistant to shock, vibration and other harsh conditions through die cast aluminium body and 5mm tempered glass cover.
- Input and output is delivered through a cable and requires an extra junction box. This junction allows cable connection between distances. Jumper cables can be determined according to the desired length of cable.
- SIRUS RGBW(A) Series is produced in grey color as standard, and is also available in different colors in RAL code upon request.

Output	RGBW(A) 45W	RGBW(A) 85W
Light Source	28 High Power Colored LEDs	28 High Power Colored LEDs
Lumen Maintenance	60.000 > hours L70 @ 50° C (full output)	60.000 > hours L70 @ 50° C (full output)
Color Range	16.7 Million additive RGB colors, white CCT 6500K	16.7 Million additive RGB colors, white CCT 6500K
Ra(CRI)	RGBW(A) Full on ≥70CRI	RGBW(A) Full on ≥70CRI
Beam Angle	30°-60°-90°-ASYM	30°-60°-90°-ASYM
Luminous Flux	2424 lm	3067 lm
Efficacy (lm/W)	58 lm/W	36 lm/W

Control & Programming

Color Resolution:	4 x 8-bit (Gamma correction)
Addressing:	RDM (Group of Remote Addressable Systems)
PWM Frequency:	1000Hz flicker free dimming
DMX / DALI Compliance:	USITT DMX512-1990
RDM Compliance:	ANSI/ESTA E1.20-2010

Electrical

Operating Voltage:	90 ~ 264VAC 50/60Hz Universal AC input
Power Consumption:	45W 85W
Connections:	Wire and Connector

Physical

Housing:	Die cast
Front Material:	Tempered glass (5mm)
Installation Brackets:	Stainless steel
Gasket:	Silicon
Color:	Grey (standard) or Custom Any RAL (optional)

Measurements:

Dimensions: (height x width x depth)	448 x 304 x 60 mm
Net weight:	6,8 kg

Environmental

Storage Temperature:	-40°C / +85°C
Ambient Temperature:	-25°C / +50°C
Operating Temperature:	-25°C / +65°C
Thermal Protection	Automatic over temperature protection(+70°C)
Cooling:	Cooling by free air convection
Ingress Protection Rating:	IP66
Impact Resistance Rating:	IK09

Certificate: EN 60598, CE

Warranty: 5-year Limited Warranty

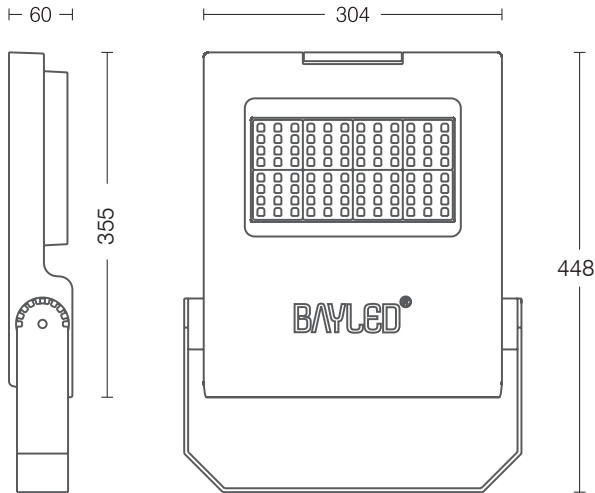
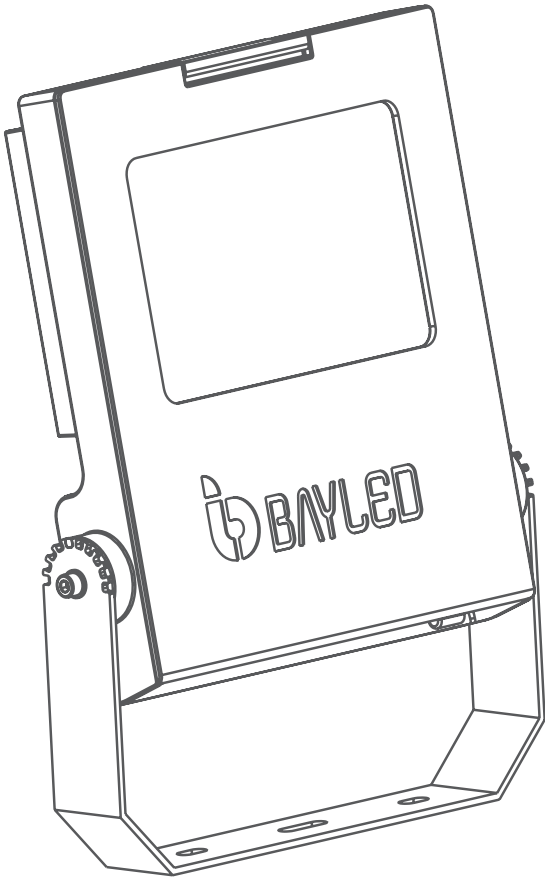

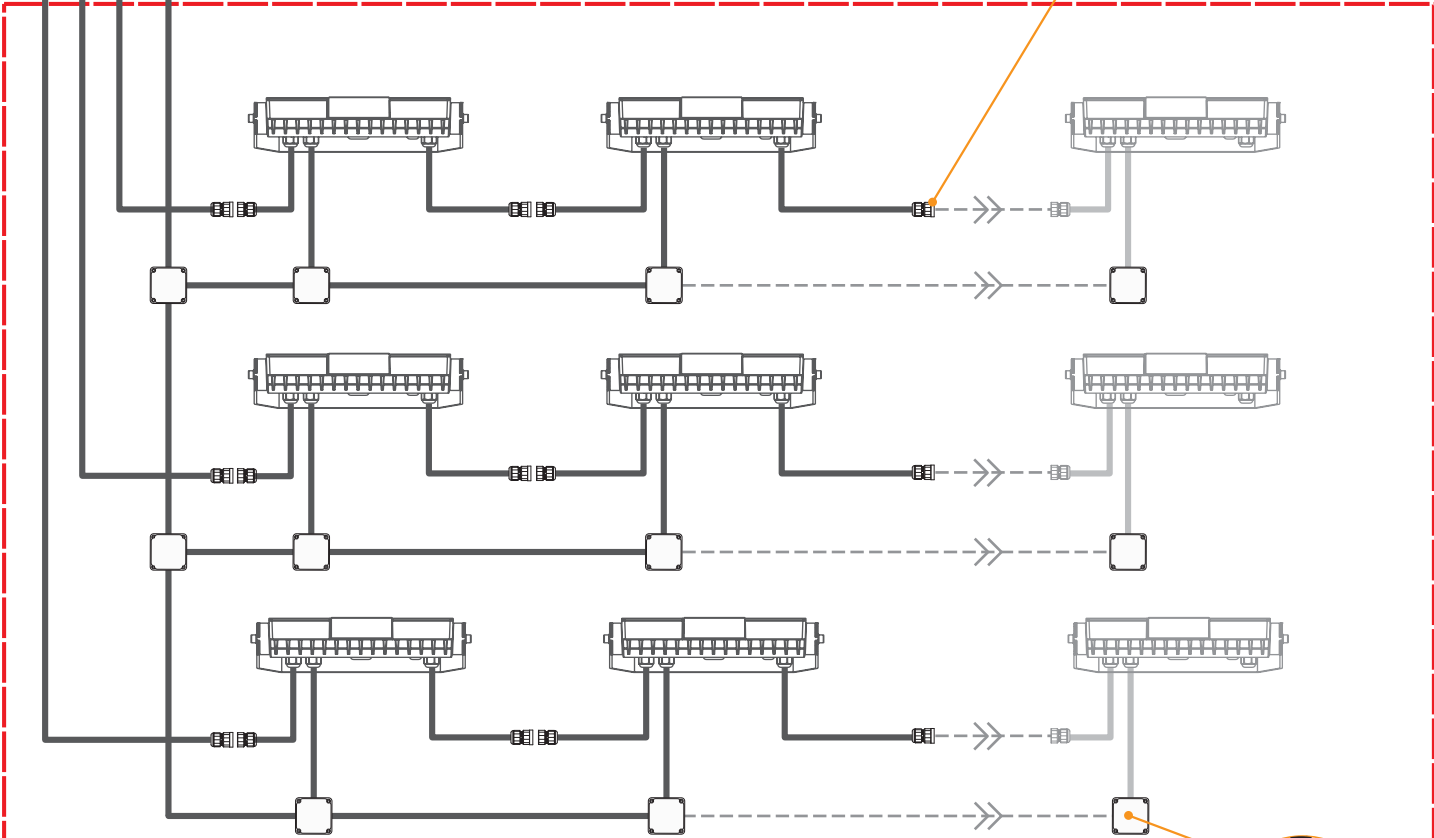
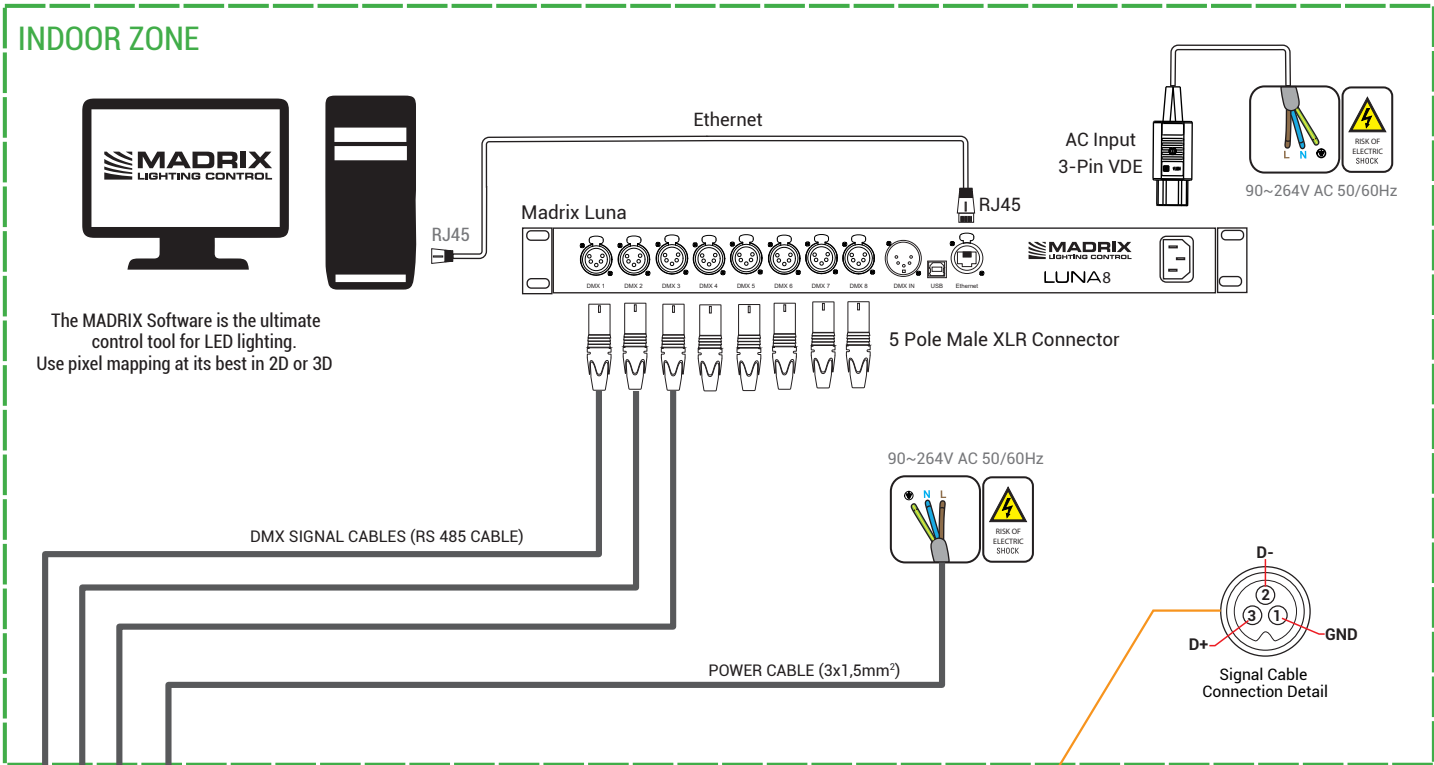

Suggestions to Reach for DMX Control

The total cable length should not be more than 300m without buffering.
 The total fixture number should not be more than 15 pcs on a single line without buffering.
 It is recommended to use only connection cables with a characteristic impedance of 120 ohm, where the DMX + and DMX - data lines are intertwined and there is a ground link as a coaxial screen surrounding the inner cores.
 120 Ω terminating resistor should be connected between the DMX + and DMX - output connections on the last fixture.
 Use a powered DMX splitter/buffer if it is necessary to separate the control link in order to feed fixtures in different locations.
 Make sure that the DMX + and DMX - connections do not get crossed at any point.

Notes:

- 1) Maximum total length of chain (fixtures and leader cable) is 50m.
- 2) Maximum total length of fixtures in chain is 15 pieces, varies by selected DMX personality.

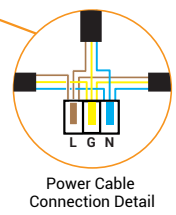

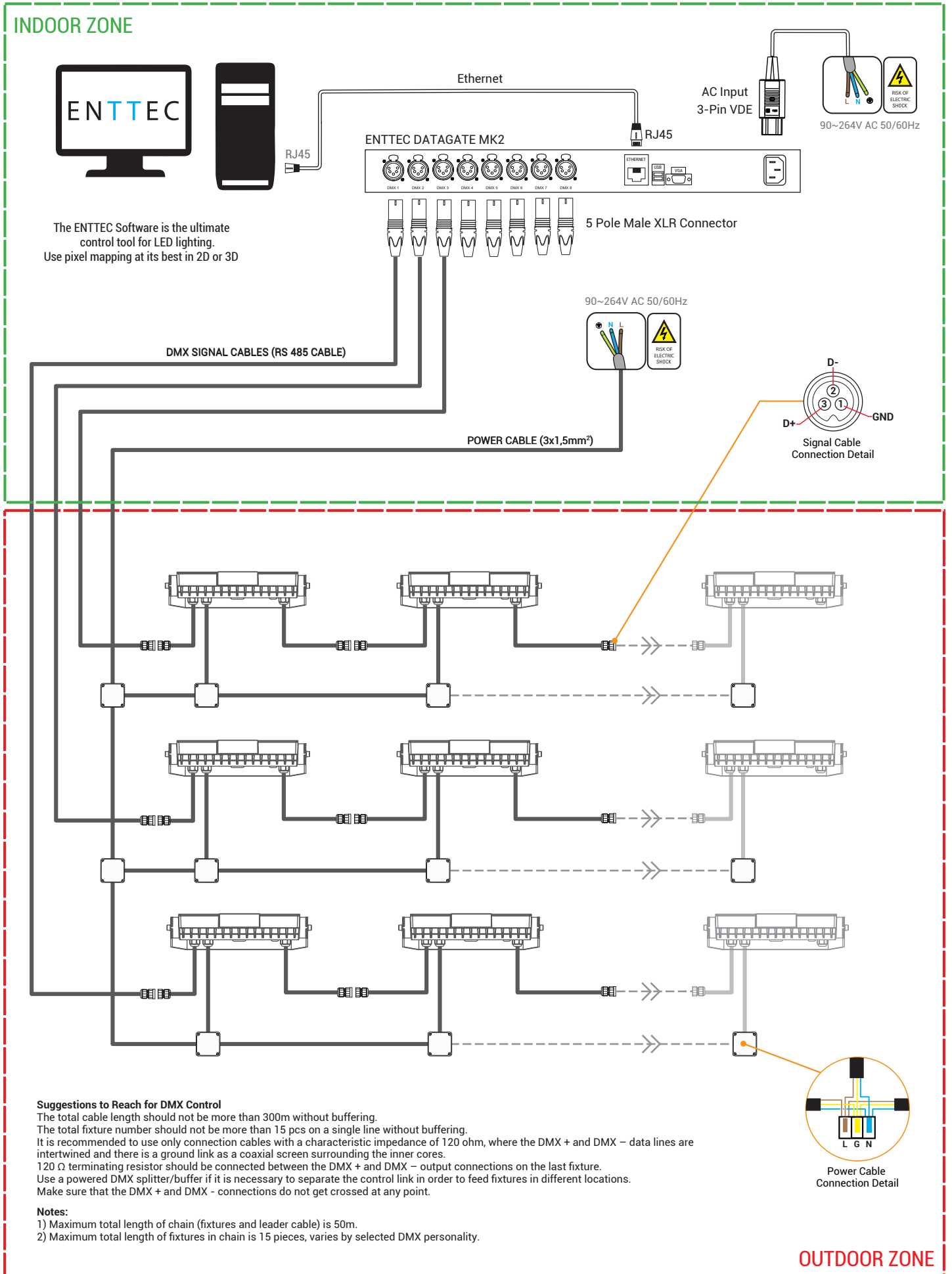

The ENTTEC Software is the ultimate control tool for LED lighting. Use pixel mapping at its best in 2D or 3D

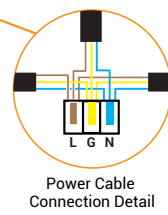
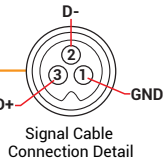

Suggestions to Reach for DMX Control
 The total cable length should not be more than 300m without buffering.
 The total fixture number should not be more than 15 pcs on a single line without buffering.
 It is recommended to use only connection cables with a characteristic impedance of 120 ohm, where the DMX + and DMX - data lines are intertwined and there is a ground link as a coaxial screen surrounding the inner cores.
 120 Ω terminating resistor should be connected between the DMX + and DMX - output connections on the last fixture.
 Use a powered DMX splitter/buffer if it is necessary to separate the control link in order to feed fixtures in different locations.
 Make sure that the DMX + and DMX - connections do not get crossed at any point.

- Notes:**
- 1) Maximum total length of chain (fixtures and leader cable) is 50m.
 - 2) Maximum total length of fixtures in chain is 15 pieces, varies by selected DMX personality.

OUTDOOR ZONE

RDM EXPLANATION**SIRUS RGBW(A) SERIES**

complies with the RDM Monitoring Command System. In order to use RDM Monitoring System, a compatible controller is required depending on the installation.

Through DMX data connection, it is possible to control the fixture's settings, send commands and receive or monitor the fixture's data.

DEVICE MANAGEMENT

	GET	SET
Device Info	√	√
DMX Start Address	√	√
Identify Device	√	√
Device Model Description	√	
Device Label	√	√
Software Version Label	√	
DMX Personality	√	√
DMX Personality Description	√	
Device Power Cycles	√	
Status ID Description	√	
Supported Parameters	√	
Parameter Description	√	

* The command names and command functions used on different RDM controllers may vary.

* Incompatible RDM controllers may cause drawbacks such as partial operation, no-operation, or incorrect fixture information.

* You can check the recommended RDM controllers on the www.bayled.eu website.

RGBW(A) POWER LED
(Beam angle options: 30°-60°-90°-ASYM)
45-06-45-32-XX-RGBW
45-06-85-32-XX-RGBW

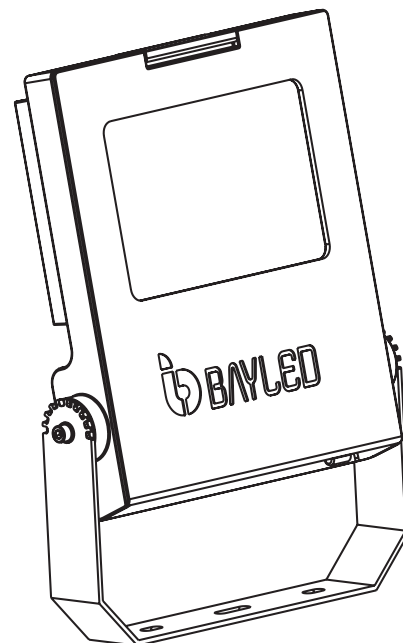

Date _____
Company _____
Project _____



BAYTAŞ AYDINLATMA LTD.ŞTİ.

Sincan Sanayi Sitesi Ahi Evran Mahallesi
255. Cadde No:84 06935 Sincan
Ankara / TÜRKİYE

Tel: +90 (312) 395 76 35 - 45
Faks: +90 (312) 395 73 65

www.bayled.eu

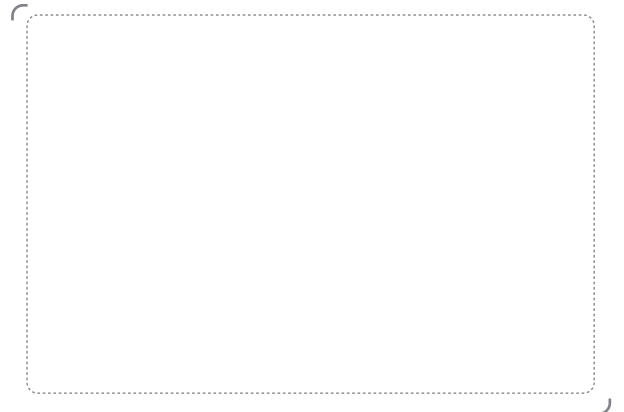

*All rights reserved
BAYLED may change products' specifications and
informations in this document without notifying in advance.
Bayled is a Baytaş Group Brand*

OUR BRANDS

