

DMX512/RDM DECODER 24CH700

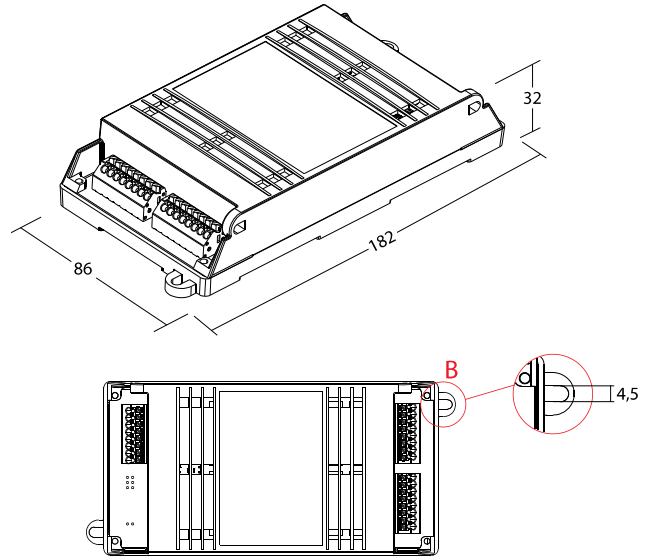

CONTROLLER

IP20 EN60598 CE

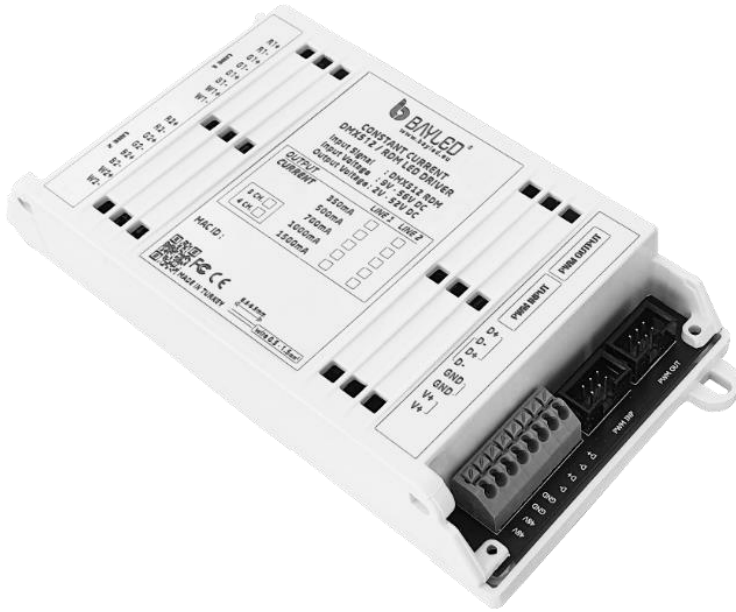

PRODUCT DATA

Input

Voltage range	9 - 56VDC
Input current sum	5768mA

Output

Voltage range	2 - 52VDC
Efficiency (max)	97% at full load and 36VDC/48VDC
Output channel	2x4 channel
Output current per ch.	700mA
Output current sum	5600mA

General Information

Control interface	DMX512/RDM
Protection class IEC	Safety class I
CE mark	CE mark
Warranty period	5 years
EU RoHS compliant	Yes

Mechanical and Housing

Housing material	Polycarbonate
Effective projected area	0,016m ²
Colour	White
Dimensions (height x width x depth)	86 x 182 x 32 mm

Application Conditions

Ambient temperature range	-30°C to +85°C
Maximum dimming level	-
Net weight (piece)	0,27 kg

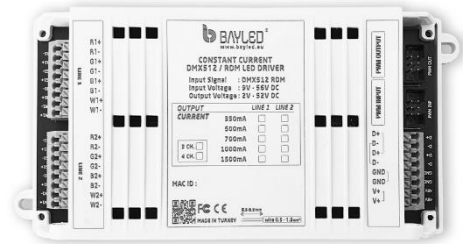

BAYLED TEKNOLOJİ A.Ş.

Ahi Evran Mah. 225. Cad. No:84 06935, Sincan ANKARA / TURKEY
T: +90 312 395 76 35 | F: +90 312 395 73 65 | sales@bayled.com.tr

Bayled is a Baytaş group brand.

Scan the QR Code to go to the product web page.



We reserve the right to change specifications without prior written notice.

Current version under: www.bayled.eu