

CANOPY 120W

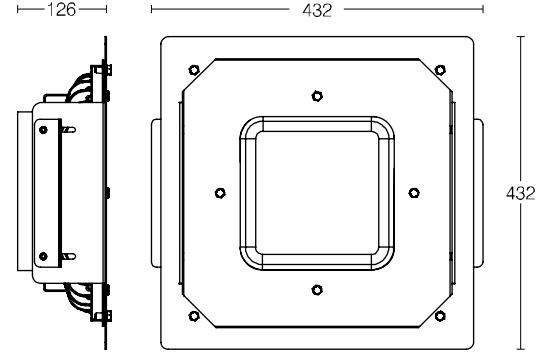

CANOPY LUMINAIRES

IP66 IK09 EN60598 CE



PRODUCT DATA

General Information

Number of light source	108 pcs
LED module	Mid Power LED's on alu-PCB
Light distribution	40°- 60°- 90°- 120°
Light source colour	3000K-4000K
Number of gear unit	1 unit
Driver / power unit	PS (Constant current)
Driver included	Yes
Optical cover / lens type	Multi lens
Control interface	On/Off
Connection	-
Cable	3x1,5 mm ²
Protection class IEC	Safety class I
CE mark	CE mark
ENEC mark	-
Warranty period	5 years
Optic type	Symmetric
EU RoHS compliant	Yes
Light source engine type	LED
LDT / IES photometric file	Available
Life span	Estimated average 50.000 hours
MacAdams	CCT tolerance within a 3 step MacAdams ellipse
Product code	81-01-120-108-XX-X (XX: Lens angle, X: Led colour)

Operating and Electrical

Input Voltage	100-305 V AC
Input frequency	50 to 60 Hz
Inrush current	546 mA
Power factor (min.)	0.92

Control and Dimming

Dimmable(optional)	1-10V - DALI
DMX	-

Mechanical and Housing

Housing material	Aluminium die-cast
Gasket	Silicone
Optic material	PMMA
Optical cover / lens material	Glass (5mm)
Fixation material	Stainless steel
Mounting device	-
Effective projected area	0,19m ²
Colour	White
Dimensions (height x width x depth)	432 x 432 x 126 mm

Approval and Application

Ingress protection code	IP66
Mech. impact protection code	IK09
Surge protection (common/differential)	6 KV/4KV (10KV/6KV optional)

Initial Performance (IEC Compliant)

Module luminous flux	17209 lm (4000K) / 16354 lm (3000K)
Luminaire luminous flux	16177 lm (4000K) / 15373 lm (3000K)
LED luminaire efficiency	135 lm (4000K) / 128 lm (3000K)
Colour Temperature	4000K / 3000K
	6500K also available up on request.
Colour rendering index	>70
Rated LED power	109W
Rated luminaire power	120W

Application Conditions

Ambient temperature range	-25°C to +55°C
Maximum dimming level	-
Net weight (piece)	9,3 kg

Fixture Run Length To calculate fixture run lengths and total power consumption for your specific installation, please ask to company assistant

BAYLED TEKNOLOJİ A.Ş.

Ahi Evran Mah. 225. Cad. No:84 06935, Sincan ANKARA / TURKEY
T: +90 312 395 76 35 | F: +90 312 395 73 65 | sales@bayled.com.tr

Bayled is a Baytaş group brand.

Scan the QR Code to go to the product web page.



We reserve the right to change specifications without prior written notice.

Current version under: www.bayled.eu