

# CANOPY 60W

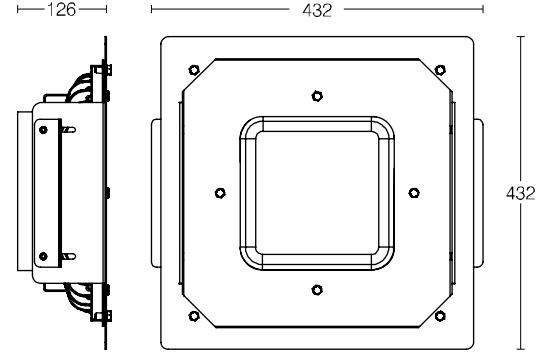

## CANOPY LUMINAIRES

IP66 IK09 EN60598 CE



## PRODUCT DATA

### General Information

Number of light source	108 pcs
LED module	Mid Power LED's on alu-PCB
Light distribution	40°- 60°- 90°- 120°
Light source colour	3000K-4000K
Number of gear unit	1 unit
Driver / power unit	PS (Constant current)
Driver included	Yes
Optical cover / lens type	Multi lens
Control interface	On/Off
Connection	-
Cable	3x1,5 mm <sup>2</sup>
Protection class IEC	Safety class I
CE mark	CE mark
ENEC mark	-
Warranty period	5 years
Optic type	Symmetric
EU RoHS compliant	Yes
Light source engine type	LED
LDT / IES photometric file	Available
Life span	Estimated average 50.000 hours
MacAdams	CCT tolerance within a 3 step MacAdams ellipse
Product code	81-01-60-108-XX-X (XX: Lens angle, X: Led colour)

### Operating and Electrical

Input Voltage	100-305 V AC
Input frequency	50 to 60 Hz
Inrush current	273 mA
Power factor (min.)	0.92

### Control and Dimming

Dimmable(optional)	1-10V - DALI
DMX	-

### Mechanical and Housing

Housing material	Aluminium die-cast
Gasket	Silicone
Optic material	PMMA
Optical cover / lens material	Glass (5mm)
Fixation material	Stainless steel
Mounting device	-
Effective projected area	0,19m <sup>2</sup>
Colour	White
Dimensions (height x width x depth)	432 x 432 x 126 mm

### Approval and Application

Ingress protection code	IP66
Mech. impact protection code	IK09
Surge protection (common/differential)	6 KV/4KV (10KV/6KV optional)

### Initial Performance (IEC Compliant)

Module luminous flux	10156 lm (4000K) / 9651 lm (3000K)
Luminaire luminous flux	9546 lm (4000K) / 9072 lm (3000K)
LED luminaire efficiency	159 lm (4000K) / 151 lm (3000K)
Colour Temperature	4000K / 3000K
	6500K also available up on request.
Colour rendering index	>70
Rated LED power	55W
Rated luminaire power	60W

### Application Conditions

Ambient temperature range	-25°C to +55°C
Maximum dimming level	-
Net weight (piece)	9,3 kg

**Fixture Run Length** To calculate fixture run lengths and total power consumption for your specific installation, please ask to company assistant

### BAYLED TEKNOLOJİ A.Ş.

Ahi Evran Mah. 225. Cad. No:84 06935, Sincan ANKARA / TURKEY  
T: +90 312 395 76 35 | F: +90 312 395 73 65 | sales@bayled.com.tr

Bayled is a Baytaş group brand.

Scan the QR Code to go to the product web page.



We reserve the right to change specifications without prior written notice.

Current version under: [www.bayled.eu](http://www.bayled.eu)